

**ECO
RIGHT**

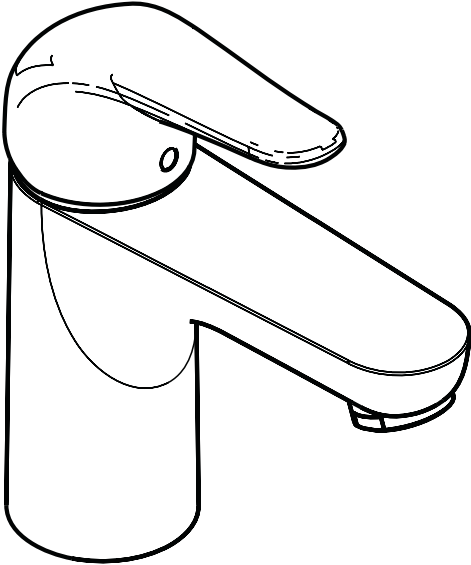

Product Features

- Single hole installation
- Single control with ceramic cartridge
- Flexible supply hoses
- Includes pop-up drain
- 1.5 gpm max.

Code Compliance

This unit meets or exceeds the following:

- ADA compliant

Available Finishes

Chrome

04193000

Brushed Nickel

04193820

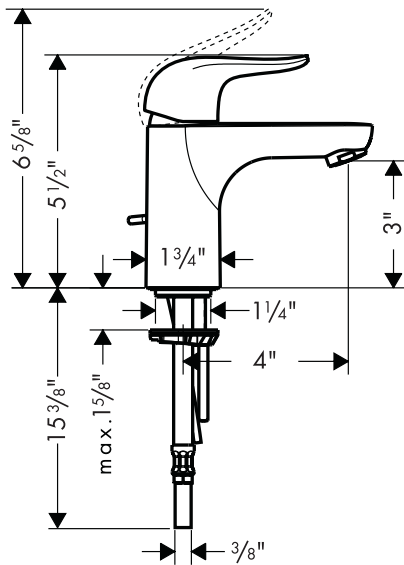

The measurements shown are for reference only.

Products and specifications shown are subject to change without notice.

Specification sheet revised 1/2009