

**ECO  
RIGHT**

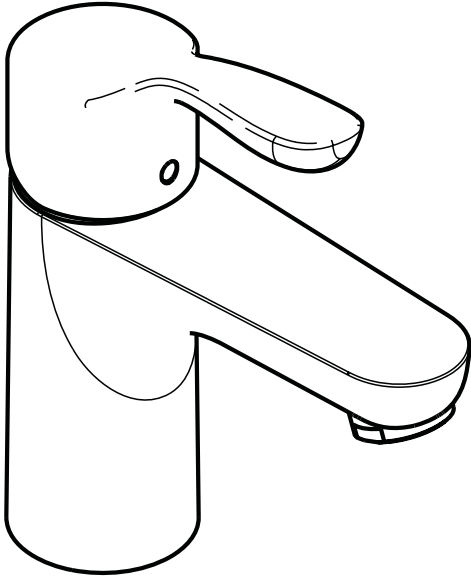

## Product Features

- Single hole installation
- Single control with ceramic cartridge
- Flexible supply hoses
- Includes pop-up drain
- 1.5 gpm max.

## Code Compliance

This unit meets or exceeds the following:

- ADA compliant

## Available Finishes

Chrome	04167000
Brushed Nickel	04167820
Polished Nickel	04167830

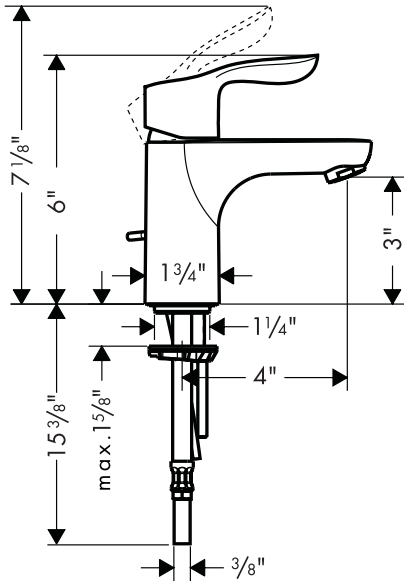

The measurements shown are for reference only.

Products and specifications shown are subject to change without notice.

Specification sheet revised 1/2009