

Trim, Talis™ S ThermoBalance II Shower Set

32324XX0

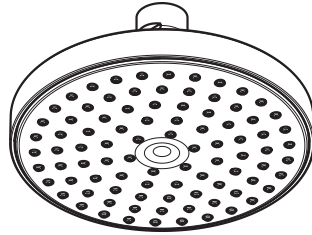
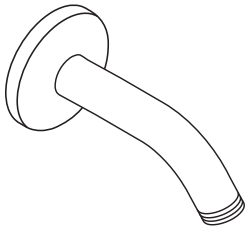

Product Features

- Set includes ThermoBalance II valve trim, Raindance S 150 AIR 1-Jet showerhead with arm, tub spout
- Max. flow rate of showerhead 2.5 gpm
- Thermostatic mixing valve with 100° safety stop, integrated volume control and two-way diverter
- Valve controls two functions
- Max. flow rate of valve 8.0 gpm @ 44 psi

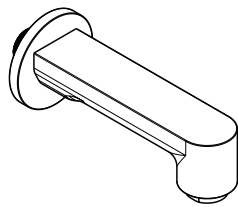
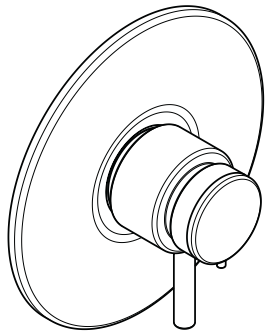

Code Compliance

This unit meets or exceeds the following:

- ASME A112.18.1
- CSA B125.1
- Listed by IAPMO

Available Finishes

Chrome

32324000

Brushed Nickel

32324820

Required Accessories

ThermoBalance II rough

06623000

or

ThermoBalance II rough with stops

06627000

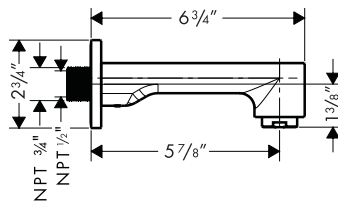
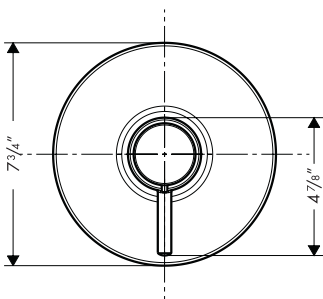
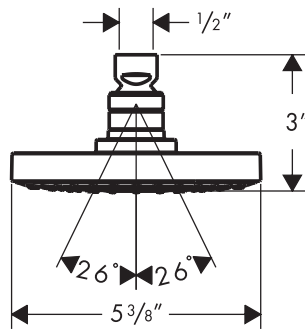
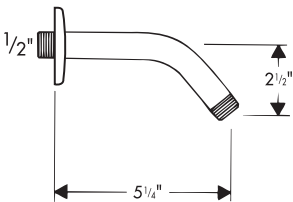

The measurements shown are for reference only.

Products and specifications shown are subject to change without notice.

Specification sheet revised 11/2008

hansgrohe