

Trim, Stratos E ThermoBalance II Shower Set

06586XX0

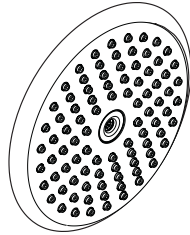
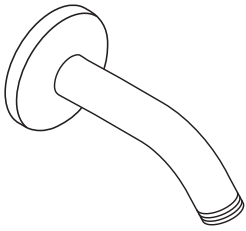

Product Features

- Set includes ThermoBalance II valve trim, Raindance E 150 AIR 1-Jet showerhead with arm, tub spout
- Max. flow rate of showerhead 2.5 gpm
- Thermostatic mixing valve with 100° safety stop, integrated volume control and two-way diverter
- Valve controls two functions
- Max. flow rate of valve 8.0 gpm @ 44 psi

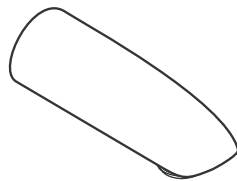
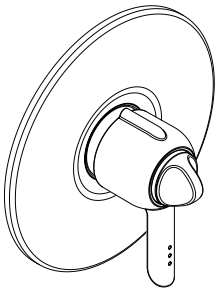

Available Finishes

Chrome	06586000
Brushed Nickel	06586820

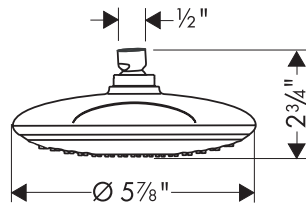
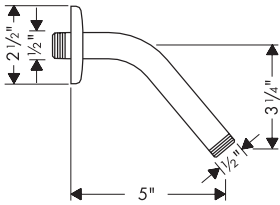

Required Accessories

ThermoBalance II rough	06623000
or	
ThermoBalance II rough with stops	06627000

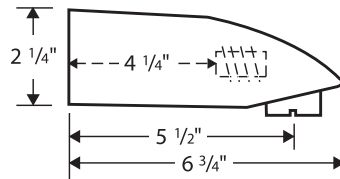
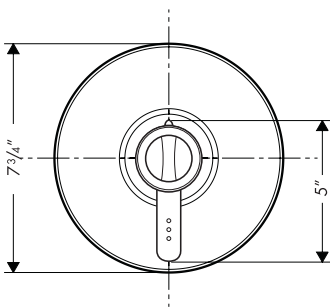

The measurements shown are for reference only.

Products and specifications shown are subject to change without notice.

Specification sheet revised 2/2008

hansgrohe