

Product Features

- Thermostatic temperature control and volume control in one unit
- Integrated two-way diverter – controls two functions
- 100° Safety stop
- High temperature limit stop may be reset to comply with local plumbing codes
- Flow rate 8.0 gpm @ 44 psi

Code Compliance

This unit meets or exceeds the following:

- ASME A112.18.1
- CSA B125.1
- Listed by IAPMO
- Approved for use in Massachusetts

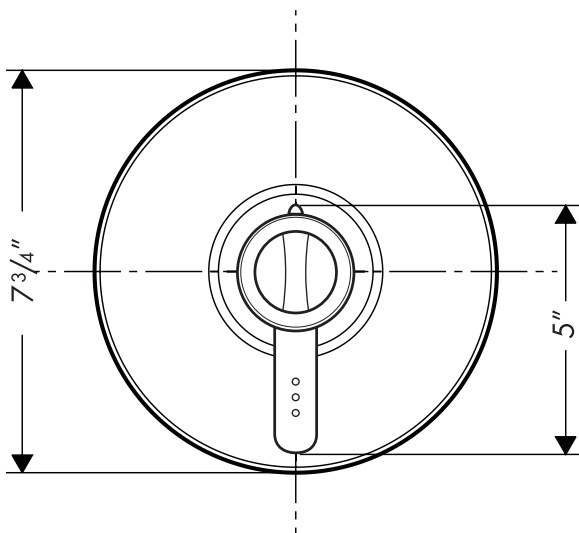

Available Finishes

Chrome	06580000
Brushed Nickel	06580820

Required Accessories

ThermoBalance II rough	06623000
or	
ThermoBalance II rough with stops	06627000

The measurements shown are for reference only.

Products and specifications shown are subject to change without notice.

Specification sheet revised 12/2007